



Installation Instructions

For Part Numbers:

250-333 700-461 Airaid Oiled Media Filter

251-333 701-461 SynthaMax Dry Media Filter - Red

2016-17 Chevrolet Camaro SS

6.2L V8

NOT LEGAL FOR SALE OR USE ON ANY POLLUTION CONTROLLED MOTOR VEHICLE IN CALIFORNIA OR STATES ADOPTING CALIFORNIA EMISSION PROCEDURES.

See AIRAID.COM for CARB status on each part for a specific vehicle.

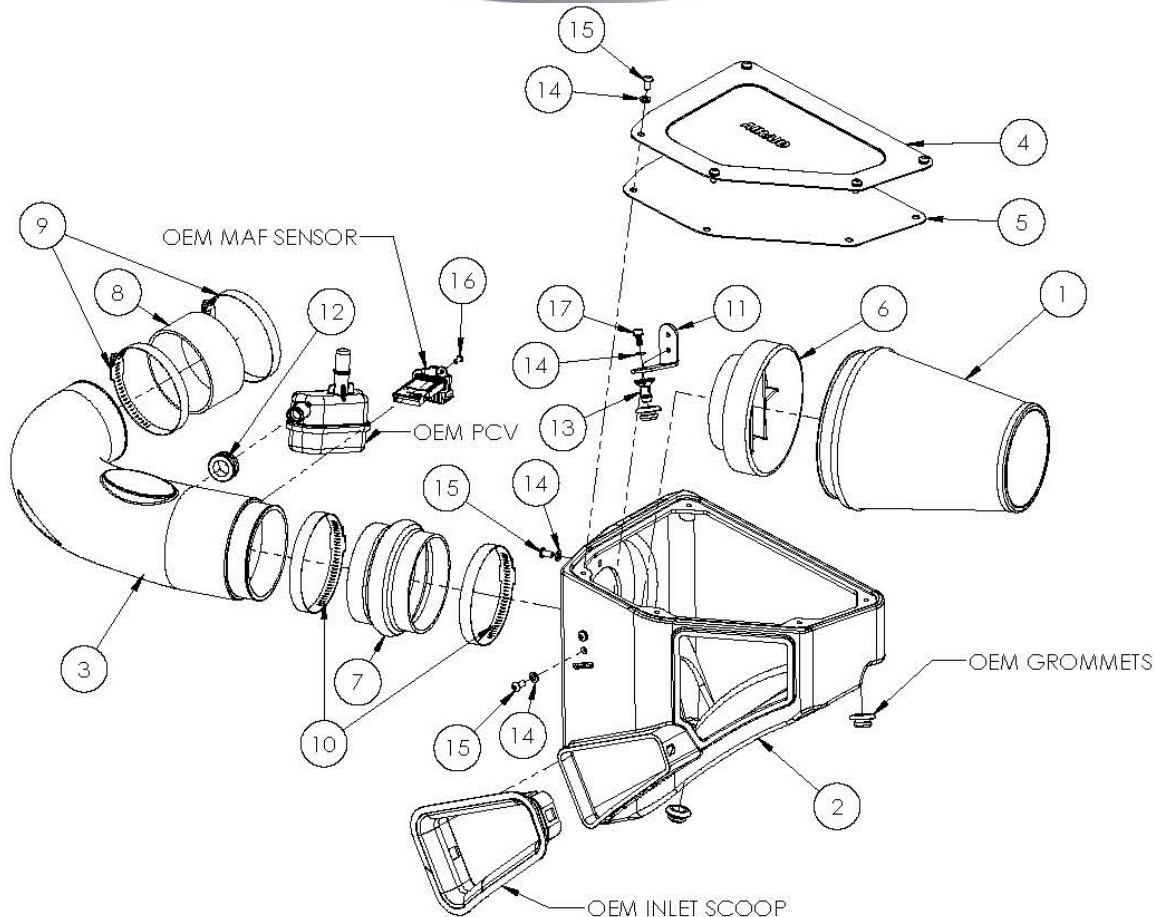

Component Identification

1	700/701-461	Airaid Premium Filter	1
2	KIT333CAB	Airaid Intake Airbox	1
3	KIT333	Airaid Intake Tube	1
4	KIT333LID	Airaid Airbox Lid	1
5	KIT333G	Airbox Lid Gasket	1
6	KITMAFADA01	Filter Adapter	1
7	KITHUMPHS05EPDM	Hump Hose	1
8	KITCOUPLER10EPDM	Coupler	1
9	KITHS60	#60 Hose Clamp	2
10	KITHS68	#68 Hose Clamp	2
11	KIT333BC	Airbox Bracket	1
12	KITGRMT19	Grommet	1
13	AEM-8-186	Airbox Mounting Post	1
14	AEM-1-3016	Flat Washer	11
15	KIT15DHC3050	1/4-20 Button Head Screw	10
16	KIT15BHC3050	#8-32 Button Head Screw	2
17	KIT60C120HCS	6mm Hex Bolt	1
18	KITPLUG03	Firewall Plug	1
19	KITSTICKER12	Airaid Badge	1

Full color instructions can be viewed on our web site at Airaid.com. If you need any assistance please call 1-800-858-3333 to speak with a representative in our Customer Service Center before returning the product.



1. Inside the trunk, on the passenger side, locate and remove the battery access panel. Disconnect the Negative battery terminal.

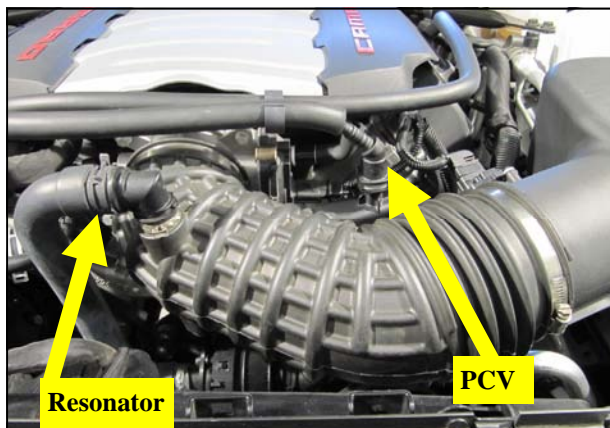

2. Compress the spring clamp on the resonator tube and separate the tube from the 90 deg. fitting in the intake tube. Depress the grey locking tab in the PCV fitting and disconnect the PCV line from the intake.

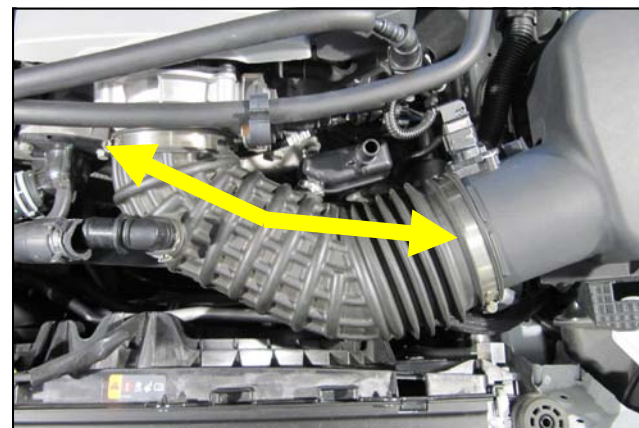

3. Loosen the clamps on both ends of the intake tube and remove it from the vehicle.



4. Disconnect the air flow meter, or MAF, in the air box lid and remove the entire airbox assembly from the vehicle.

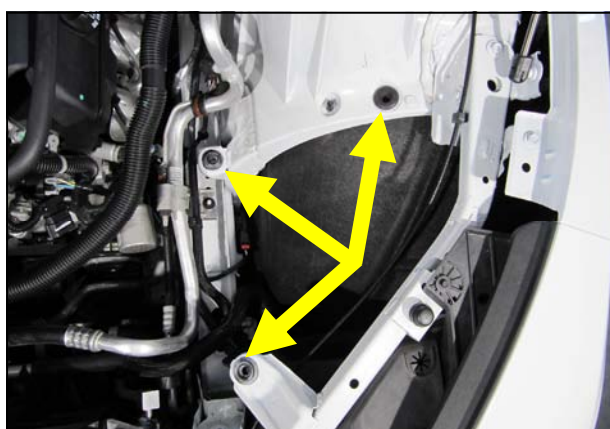

5. Ensure that all 3 airbox mounting grommets remain in the vehicle.



6. Remove the two bolts in the resonator diaphragm bracket using a T-50 Torx bit or with a pair of locking pliers as shown. The resonator, bolts and bracket will not be used with the Airaid.



7. Locate the upper half of the resonator tube near the master cylinder and disconnect the tube retainers on the strut tower brace and the A/C line.



8. At the firewall, remove the 6mm flange nut at the resonator tube base. Turn the tube 1/4 turn Clockwise and remove it from the vehicle.



9. Insert the Firewall Plug into the resonator tube hole.

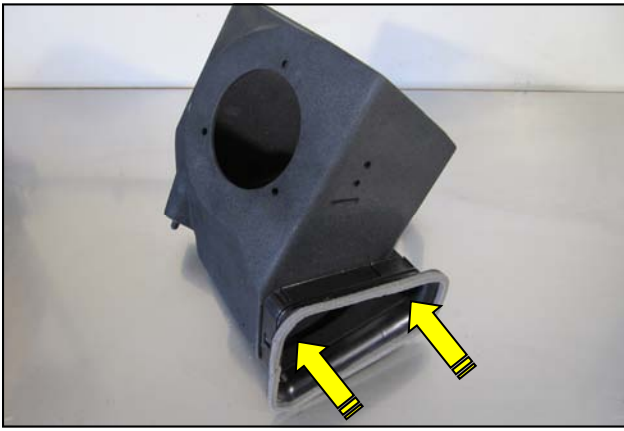

10. Transfer the factory air box inlet onto the Airaid air box as shown.

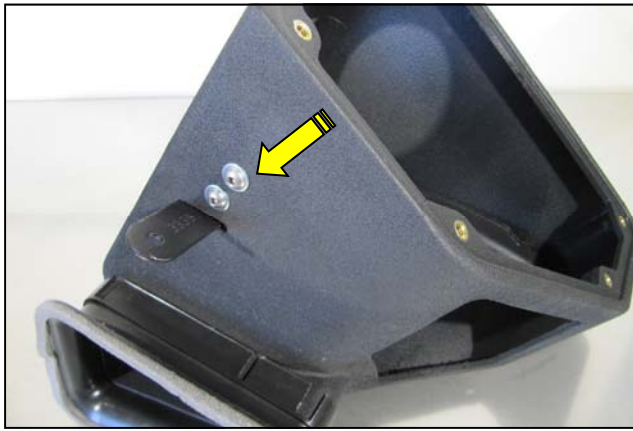

11. Slide the Airbox Bracket into the slot above the air inlet, from inside the box, and secure it using two sets of 1/4-20 Button Head Screws and Flat Washers.

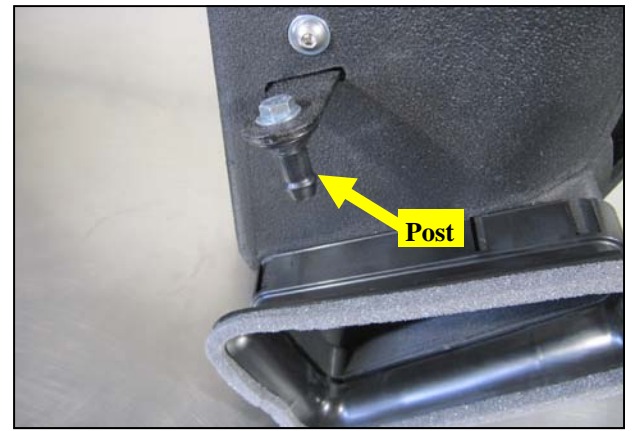

12. Install the Airbox Mounting Post onto the Bracket, as shown using the 6mm Hex Bolt and one Flat Washer.

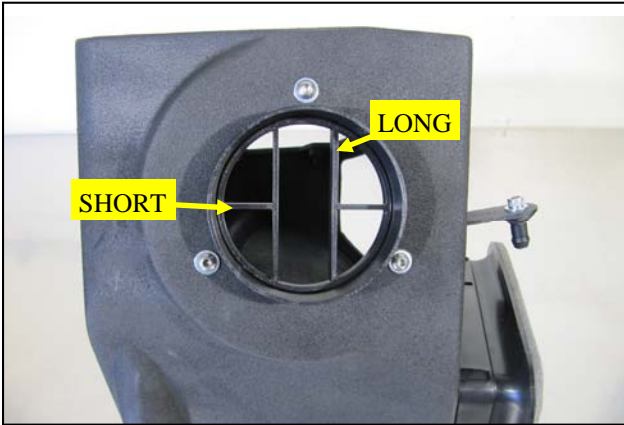

13. Install the Filter Adapter onto the Airbox using three sets of 1/4-20 Button Head Screws and Flat Washers. Note the positioning of the Adapter in the Airbox. When properly installed, the long air vanes are vertical and the short vanes are horizontal.



14. Transfer the MAF Sensor from the factory airbox, into the Airaid Intake Tube and secure it using the supplied #8 Button Head Screws. Insert the Grommet into the Intake Tube as shown.

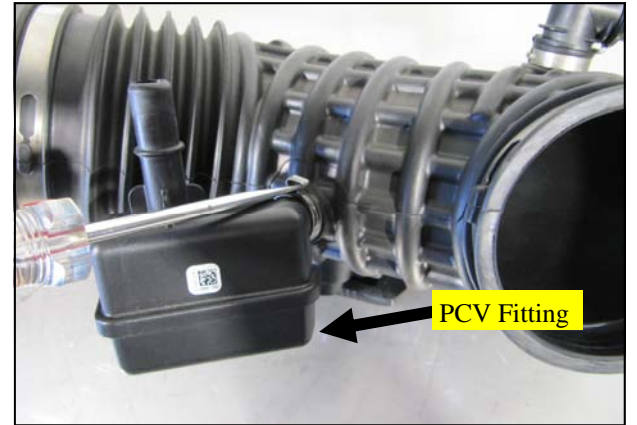

15. Using a small flat tip screwdriver, uncrimp the clamp securing the PCV fitting to the intake tube.



16. Transfer the PCV fitting into the Grommet in the Airaid Intake Tube. Apply the Airaid Badge to the Intake Tube as shown.



17. Place the Airaid Airbox assembly into the engine compartment as shown, with the mounting posts only fully seated in all three grommets.

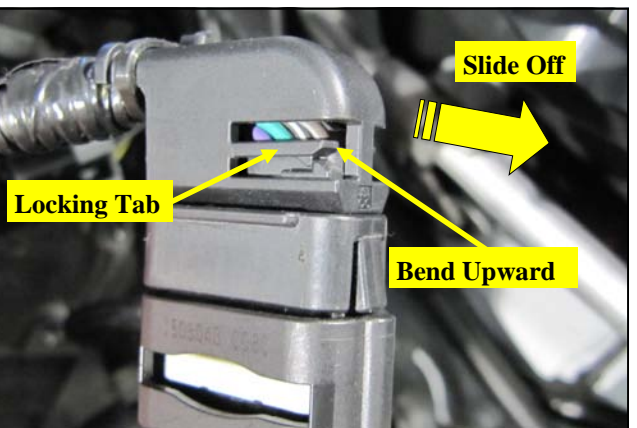

18. The connector for the MAF sensor has a 90 degree wire guide on it. Cut the zip tie on the guide. Locate the locking tabs on both sides of the guide and bend the tabs upward to slide the guide off of the connector. This will not be used with the Airaid Intake.



19. Slide the Hump Hose and #68 Clamps onto the Filter Adapter.



20. Slide the Coupler and #60 Clamps onto the throttle body as shown.

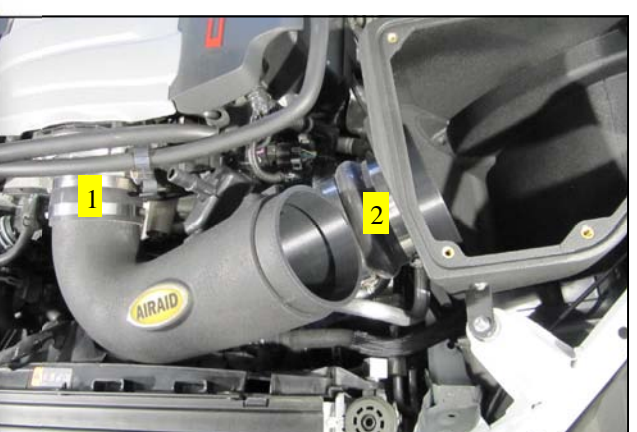

21. Insert the Intake Tube into the Coupler first, then into the Hump Hose.



22. Align the Intake Tube and tighten all four Clamps.



23. Install the Airaid Premium Airfilter on to the Filter Adapter in the Airbox.



24. Prepare the Airbox Lid for Gasket installation by cleaning the mounting surface using a Prep Solvent or equivalent. Remove the adhesive backing from the Gasket and carefully apply it as shown with the screw holes aligned.



25. Remove the protective film from the other side of the Lid and mount it to the Airbox using 5 sets of 1/4-20 Button Heads and Flat Washers.

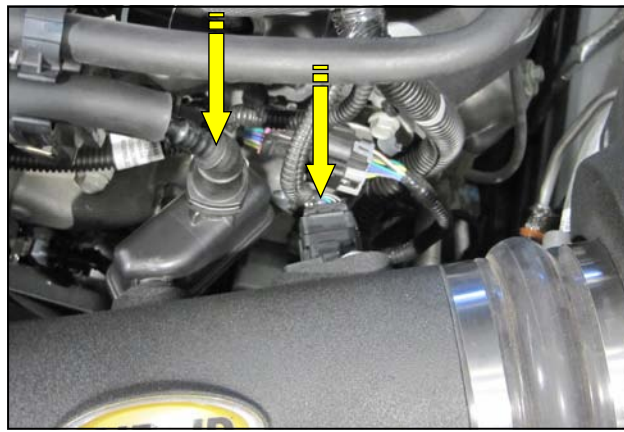

26. Reconnect the PCV line and the MAF.



27. Slowly lower the hood to test clearances. Make sure all clamps, hoses, bolts, and screws are tight. Double check the hood clearance. Reconnect the negative battery terminal and re install the access panel.

FILTER IDENTIFICATION

700-461 Airaid Oiled Media

701-461 Airaid SynthaMax Dry Media - Red

Thank you for purchasing the Airaid Intake System. Contact Airaid @ (800) 498-6951 8:00 AM - 5:00 PM MST weekdays for questions regarding fit or instructions that are not clear to you. Your Airaid Intake System was carefully inspected and packaged. Check that no parts are missing, or were damaged during shipping. If any parts are missing, contact Airaid. The air filter element is protected from direct exposure to water and debris; care should be taken not to drive through deep water. **WATER INGESTION IS THE DRIVERS RESPONSIBILITY!** The air filter is reusable and should be cleaned periodically.

For your Oiled media filter we suggest using the AIRAID Filter Tune-Up Kit.

P/N 790-551 Aerosol Spray
P/N 790-550 Squeeze Spray



SynthaMax

Do Not Oil

Synthamax Air Filters do not require oil. Service air filter as needed by cleaning with common non-petroleum all-purpose household cleaner and water. Simple Green®, Formula 409® or equivalent works great. Apply cleaner to outside of air filter and allow to soak. Then flush filter clean from the inside out with a garden hose and repeat steps if necessary. Do not apply high pressure water or air to clean filter. Allow filter to air dry and reinstall.



NOT LEGAL FOR SALE OR USE ON ANY POLLUTION CONTROLLED MOTOR VEHICLE IN CALIFORNIA OR STATES ADOPTING CALIFORNIA EMISSION PROCEDURES.

See AIRAID.COM for CARB status on each part for a specific vehicle.

This page is intentionally left blank.