

AIR RAID®

INTAKE SYSTEMS

Installation Instructions
Part Number 400-140-2
2004-08 Ford F-150
2006-08 Lincoln LT
5.4L V-8

****Does Not Fit Heritage Body****

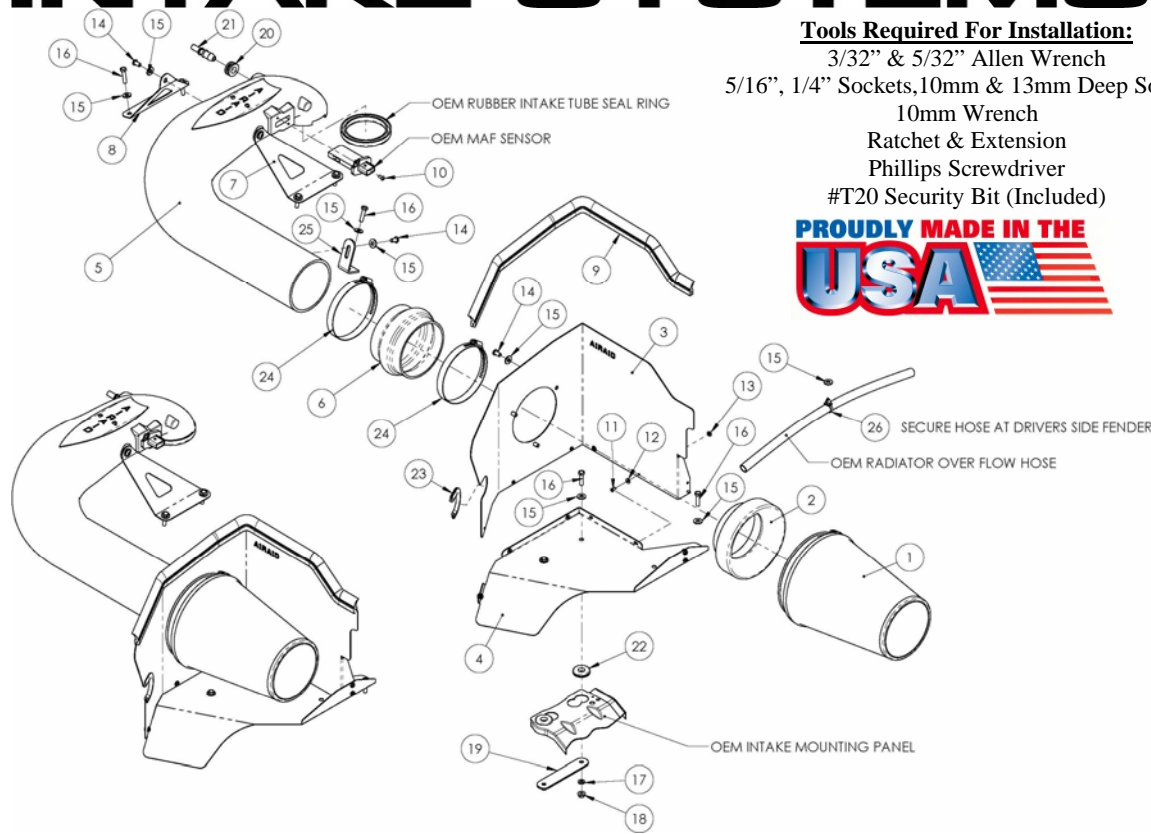

Tools Required For Installation:

- 3/32" & 5/32" Allen Wrench
- 5/16", 1/4" Sockets, 10mm & 13mm Deep Sockets
- 10mm Wrench
- Ratchet & Extension
- Phillips Screwdriver
- #T20 Security Bit (Included)



Packing List:

#1	700-469	Airaid Premium Filter	1
#2	KIT1121MAFADA	Air Filter Adapter	1
#3	KIT1402MAFC	MAF Panel Coated	1
#4	KIT1402BPC	Bottom Panel Coated	1
#5	KIT140T1	Airaid Intake Tube	1
#6	KITHUMPHS05	Urethane Hump Hose	1
#7	KIT140DSTBC	Drivers Side Bracket	1
#8	KIT140PSTBC	Passenger Side Bracket	1
#9	KITWSTRIP02	Weather Strip 26 1/2"	1
	KIT1402HP	Hardware & Instructions	1
#10	KIT15BHC3038	8-32 x 3/8" Button Head Screw	2
#11	KIT6C31MXPPZ	6-32 x 5/16" Screw	7
#12	KIT6NWSAPZ	#6 Flat Washer	7
#13	KIT6CNKEPZ	6-32 Keps Nut	7
#14	KIT15DHC3050	1/4-20 x 1/2" Button Head Bolt	6
#15	KIT09FWZ019	1/4" Flat Washer	15
#16	KIT60C250HCS	M6-1 x 25 Hex Bolt	8
#17	KIT09LWZ025	1/4" Lock Washer	2
#18	KIT60CNFHPZ	M6 Hex Nut	2
#19	KIT115B	Long/Narrow Bracket	1
#20	KITGRMT03	Rubber Grommet	1
#21	KITFITTING05	Aluminum Fitting	1
#22	KITGRMT05	Rubber Grommet	2
#23	KITX1011	Rubber Trim 4"	1
#24	KITHS72	#72 Hose Clamp	2
#25	KIT140B	L-Shaped bracket	1
#26	KIT131MOUNT	Black Plastic Hose Mount	1
	KITBIT#T20	T-20 Security Bit	1



1. Disconnect the negative battery cable.

Push the green tab, and disconnect the factory breather line from the intake tube. Slide the red tab, and disconnect the Mass Air Flow (MAF) sensor wiring harness from the sensor. Unclip the battery cable from the front of the factory airbox.



2. Using a 10mm deep socket, remove the 4 tower bolts, two on each side of the factory airbox. Remove one bolt holding the factory intake tube to the mounting bracket. Remove the complete factory intake system.

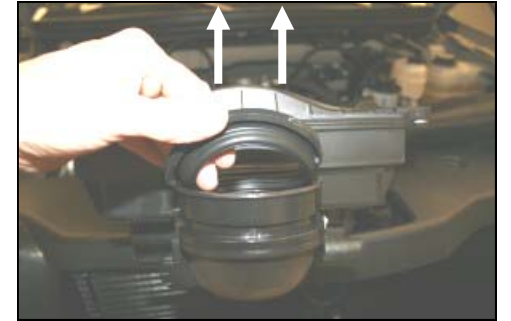

3. Remove the rubber seal from the factory airbox and save it for re-installation in step #6.



4. Using the provided T-20 Security Bit, remove the two screws, and remove the MAF sensor from the factory intake tube. Save the sensor for re-installation in the next step.



5. Re-install the MAF sensor into the Airaid Intake Tube (#5) using two 8-32 x 3/8" button head screws (#10). **Do not over tighten! Do Not Use The Factory Screws!!**



6. Re-install the rubber seal removed in step #3 onto the Airaid Intake Tube. Use caution to align the notch in the tube with the notch in the seal.

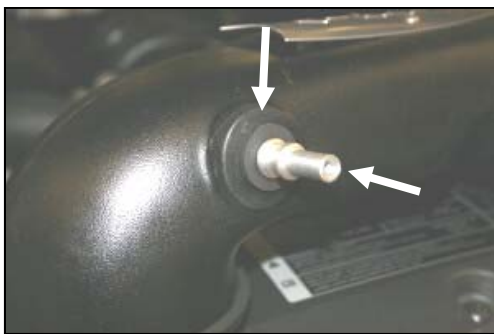

7. Install the rubber grommet (#20) into the Airaid Intake Tube, and then install the aluminum fitting (#21) into the grommet, tapered end first.



8. Slip two rubber grommets (#22) into the large holes in the bracket on the drivers side fender, then slide them sideways into the smaller holes as shown.

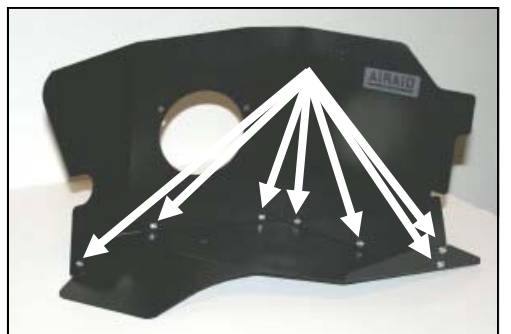

9. Assemble the two Cool Air Dam (CAD) panels (#3, #4) using seven 6-32 x 5/16" screws (#11), #6 flat washers (#12), and 6-32 keps nuts (#13).

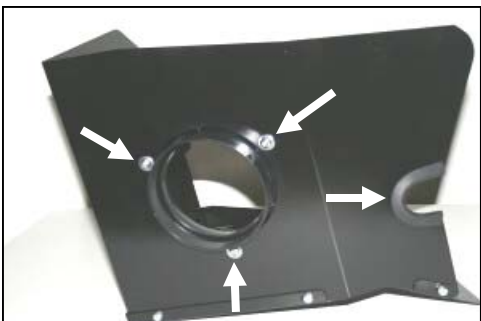

10. Install the air filter adapter (#2) into the CAD using three 1/4-20 x 1/2" button head bolts (#14) and 1/4" flat washers (#15). Next, install the 4" rubber trim (#23), as shown.

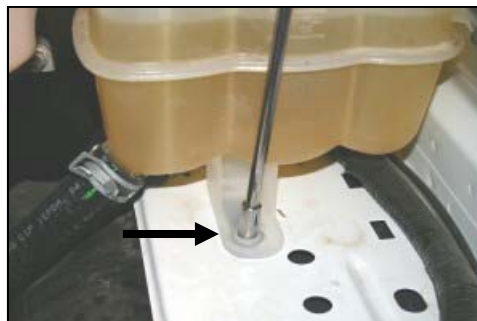

11. Using a 5/16" socket, remove one bolt from the factory coolant reservoir mount.

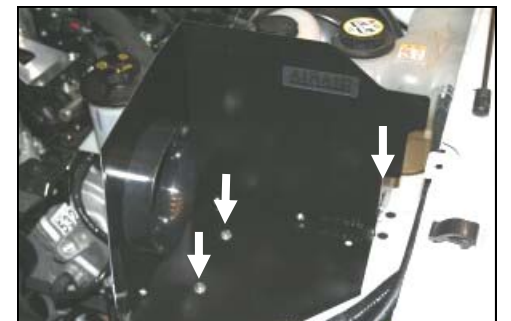

12. Install the CAD into the vehicle with one 6mm bolt (#16) and 1/4" flat washer (#15) through the panel, through the coolant reservoir mount and into the speed nut below it. Using two 6mm bolts (#16) two 1/4" flat washers (#15), two 1/4" lock washers (#17), and two M6 hex nuts (#18), insert the two bolts thru the CAD, thru the grommets, and thru the long/narrow bracket (#19). Use the line drawing above for reference.

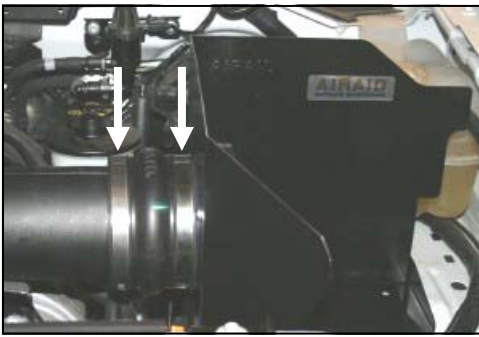

13. Install the urethane hump hose (#6) onto the air filter adapter (#2) with two #72 hose clamps (#24), leave the clamps loose for now. Slide the Airaid Intake Tube into the hump hose first and then onto the throttle body.

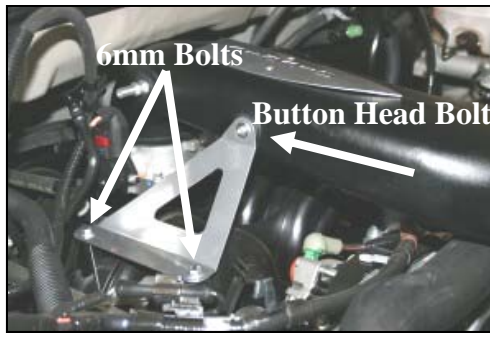

14. Install the two brackets (#7, #8) from the Airaid Intake tube onto the intake manifold using two 1/4 -20 x 1/2" button head bolts (#14), and 1/4" flat washers (#15) on the tube, and four 6mm bolts (#16), and 1/4" flat washers (#15) on the bottom. Leave the button head bolts loose for now.

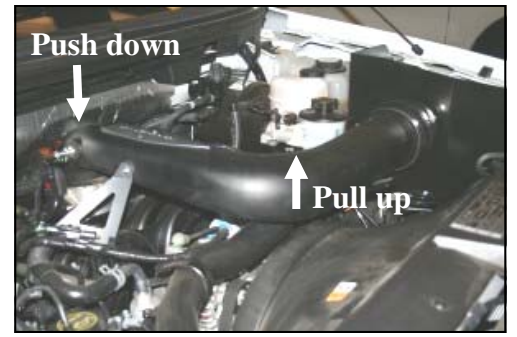

15. While gently lifting on the tube next to the radiator, and pushing down on the tube over the throttle body, tighten the two button head bolts on top of the mounting brackets. This will help make sure the Airaid Intake Tube is sealing on the throttle body.



16. Install the L-shaped bracket (#25) using one 1/4 -20 x 1/2" button head bolt (#14) and 1/4" flat washer (#15) thru the oval slot into the backside of the tube. Next, install one 6mm bolt (#16) and 1/4" flat washer (#15) thru the round hole into the factory bracket. Tighten the hose clamps on the hump hose. Some adjustment of the factory bracket may be necessary for a proper fit, see step #17.



17. Factory tolerances may require adjusting the factory bracket to align the tube and hump hose with the filter adapter. Therefore, it may be necessary to loosen the two mounting nuts with a 13mm deep socket, and adjust it.



18. Slip the black plastic hose mount (#26) over the radiator overflow hose. Next, place one 1/4" flat washer (#15) over the hole on the inner drivers side fender. Slide the hose mount prongs thru the fender and thru the washer.



19. Install the Airaid Premium Filter (#1) onto the air filter adapter (#2), and tighten the clamp. Next install the weather strip (#9) onto the top of the CAD as shown. (Hint: start at one end of the CAD and work towards the other end).



20. Re-connect the breather hose to the Airaid Intake Tube, and the MAF sensor wiring harness to the sensor. Refer to step #1.

21. **Double check your work!** Make sure there is no foreign material in the intake path. Make sure all clamps, hoses, bolts, and screws are tight.

22. **Reconnect the negative battery cable!**

Included with your Airaid Intake System is a sticker with a California Air Resources Board (C.A.R.B.) Executive Order (EO) number. This sticker must be placed in plain view inside of the engine compartment. Failure to do so may prevent you from passing a smog inspection.

Before!



After!



Thank you for purchasing the Airaid Intake System. Contact Airaid @ (800) 498-6951 8:00 AM - 5:00 PM MST weekdays for questions regarding fit or instructions that are not clear to you. Your Airaid Intake System was carefully inspected and packaged. Check that no parts are missing, or were damaged during shipping. If any parts are missing, contact Airaid. The air filter element is protected from direct exposure to water and debris; care should be taken not to drive through deep water. WATER INGESTION IS THE DRIVERS RESPONSIBILITY! The air filter is reusable and should be cleaned using the Airaid Filter Tune-Up Kit periodically.

Don't Forget Your AIRAID Filter Tune-Up Kit!



P/N 790-551 Aerosol Spray
P/N 790-550 Squeeze Spray



Instructions Revision
Date: 12/03/07