

# AIR AID®

## INTAKE SYSTEMS

**Installation Instructions**  
**Part Number 201-197**  
**2007 Chevrolet Silverado 1500/2500/3500**  
**Tahoe/Suburban/Avalanche/**  
**GMC Sierra 1500/2500/3500**  
**Yukon/Yukon XL**  
**Denali/Denali XL**  
**Cadillac Escalade/ESV/EXT**  
**4.8L, 5.3L, 6.0L, 6.2L V-8**  
**\*New Body Style Only\***  
**\*With Electric Cooling Fans Only\***

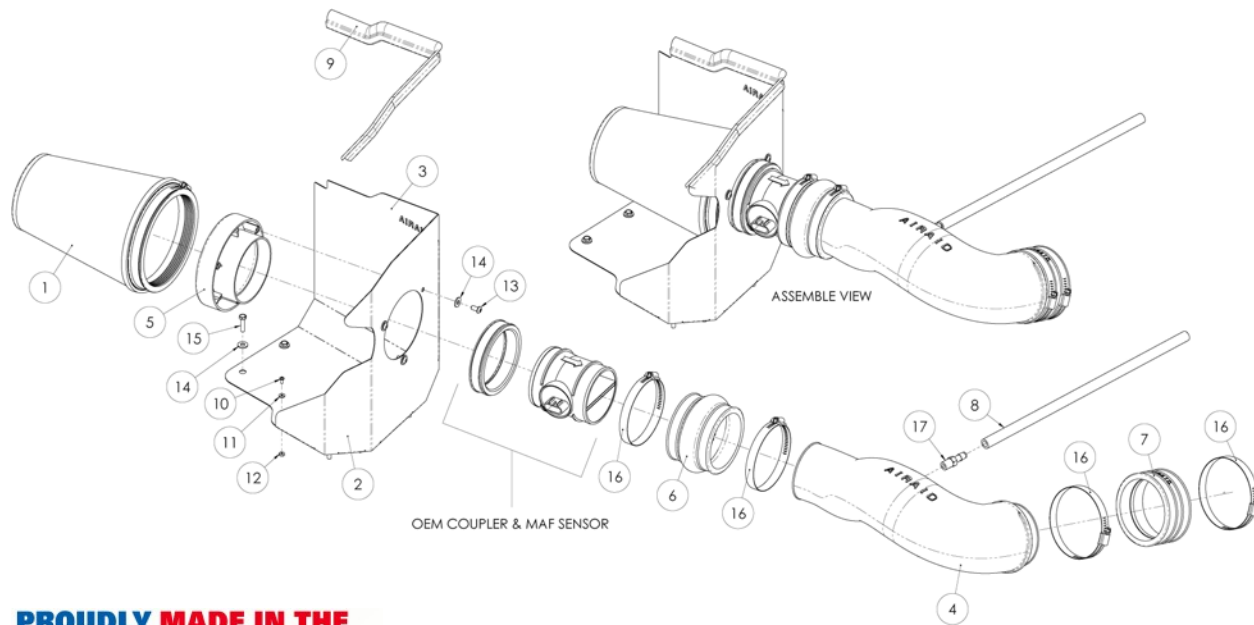

**Packing List:**

#1	701-469	Airaid Premium Filter	1
#2	KIT196MAFDAC	MAF Panel	1
#3	KIT196RRDAMC	Rear Air Dam Panel	1
#4	KIT996T	Airaid Intake Tube	1
#5	KIT112MAFADA	Air Filter Adapter	1
#6	KITHUMPHS18	Urethane Hump Hose	1
#7	KITCOUPLER10	Urethane Coupler	1
#8	KITHOSE06	3/8" x 14" Breather Hose	1
#9	KITWSTRIP02	Weather Strip 20 3/4"	1
	KIT197HPS	Hardware & Instructions	1
#10	KIT6C31MXPPZ	6-32 x 5/16" Screw	5
#11	KIT6NWSAPZ	#6 Flat Washer	5
#12	KIT6CNKEPZ	6-32 Keps Nut	5
#13	KIT15DHC3050	1/4 - 20 x 1/2" Button Head Bolt	3
#14	KIT09FWZ019	1/4" Flat Washer	7
#15	KIT60C250HCS	M6 - 1 x 25 Hex Bolt	4
#16	KITHS64	#64 Hose Clamp	4
#17	KITFITTING01	1/4" NPT x 3/8" Barb Fitting	1

**Tools Required For Installation:**

5/16", 10mm Sockets  
 Ratchet & Extension  
 Phillips Screwdriver  
 5/32" Allen Wrench



**1. Disconnect the negative battery cable.**  
 Remove the factory beauty cover by lifting up on the front, and then pulling the cover towards the front of the vehicle. It is only held in place by grommets.

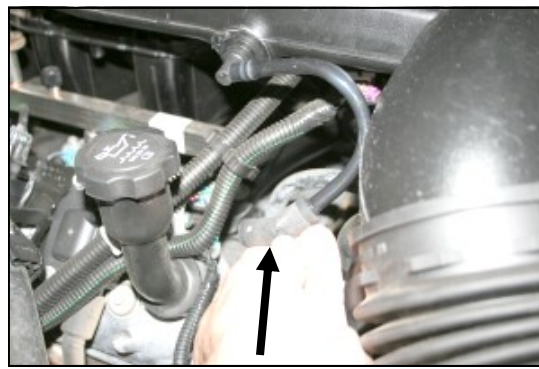

**2. Disconnect the factory breather hose at the valve cover.**



**3. Separate the factory intake tube from the plastic clamp that secures the radiator hose to the tube. A firm downward push will usually do it.**

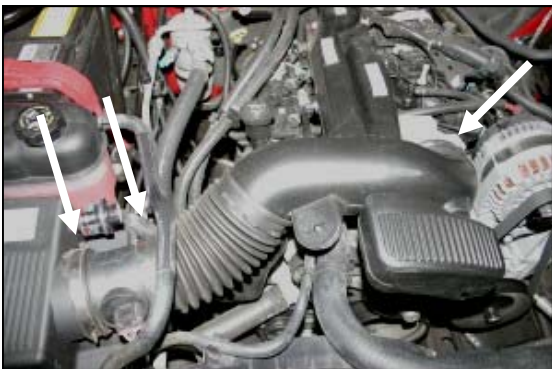

**4. Loosen three hose clamps. One at each end of the factory intake tube, and one on the Mass Air Flow sensor (MAF) where it clamps to the factory airbox.**



**5. Slide the factory intake tube off of the MAF sensor, rotate it up so that it disengages from the mounting grommet on the intake manifold, and then slide it forward off of the throttle body and remove it from the vehicle.**

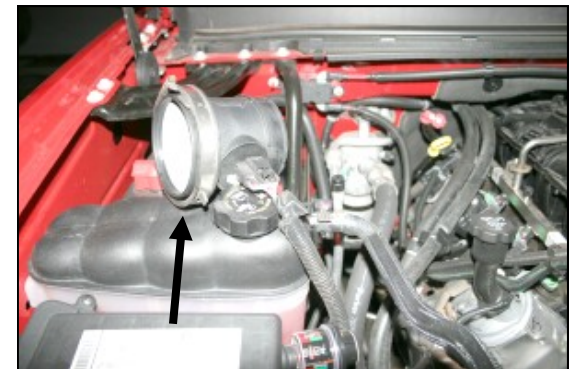

**6. Remove, and set aside the MAF sensor from the factory airbox using caution to retain the factory clamp and seal.**



**7. Rock the factory airbox back and forth to loosen it from the mounting grommets, and remove it from the vehicle.**

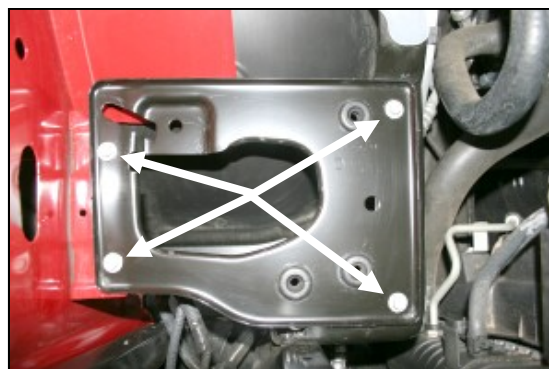

**8. Using a 10mm socket, remove four bolts, and then remove the factory airbox mounting plate from the vehicle.**



**9. Assemble the Cool Air Dam panels (CAD) (#2 & #3) using five 6-32 x 5/16" screws (#10), #6 flat washers (#11), and 6-32 keps nuts (#12). Next install the air filter adapter (#5) into the panels as shown using three 1/4 - 20 x 1/2" button head bolts (#13), and 1/4" flat washers (#14).**

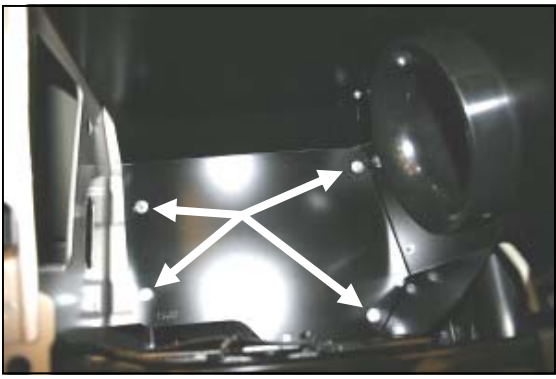

**10.** Install the Airaid CAD into the vehicle replacing the factory airbox. Secure the CAD using four M6 x 1.25 Hex Bolt (#15), and 1/4" flat washers (#14). Do not over tighten the four bolts.



**11.** Reinstall the MAF sensor onto the filter adapter, and tighten the clamp.

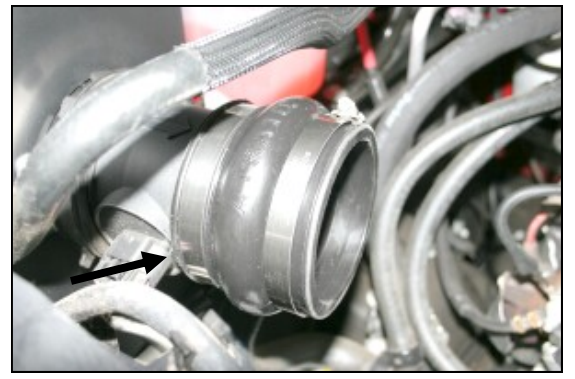

**12.** Install the urethane hump hose (#6), and two #64 hose clamps (#16) onto the MAF sensor as shown. Tighten only the clamp on the MAF sensor at this time.

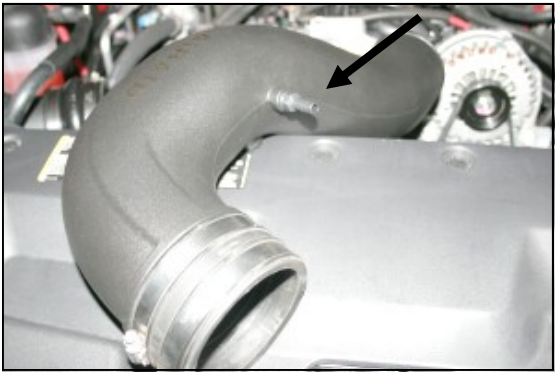

**13.** Install the 1/4" NPT x 3/8" Barb Fitting (#17) into the Airaid Intake Tube as shown. Next install the urethane coupler (#7) onto the throttle body end of the tube using two #64 hose clamps (#16). Tighten *only* the clamp on the tube.



**14.** Install the Airaid Intake Tube into the hump hose first, and then onto the throttle body. Adjust it for fit, and tighten the hose clamps. Next install the 3/8" x 14" breather hose (#8) between the 1/4" NPT x 3/8" barbed fitting in the tube, and the factory port on the valve cover.



**15.** Install the Airaid Premium Filter (#1) onto the air filter adapter, and tighten the hose clamp. Next install the provided weather strip (#9) onto the top of the CAD. *For ease of install, start at the inner fender, and work your way towards the radiator.* Reinstall the beauty cover.

**16. Double check your work!**

Make sure there is no foreign material in the intake path. Make sure all clamps, hoses, bolts, and screws are tight.

**17. Reconnect the negative battery cable!**

Thank you for purchasing the Airaid Intake System. Contact Airaid @ (800) 498-6951 8:00 AM - 5:00 PM MST weekdays for questions regarding fit or instructions that are not clear to you. Your Airaid Intake System was carefully inspected and packaged. Check that no parts are missing, or were damaged during shipping. If any parts are missing, contact Airaid. The air filter element is protected from direct exposure to water and debris; care should be taken not to drive through deep water. WATER INGESTION IS THE DRIVERS RESPONSIBILITY!

*Before!*



*After!*



**SynthaMax**

**Do Not Oil**



**Synthamax Air Filters do not require oil.** Service air filter as needed by cleaning with common non-petroleum all-purpose household cleaner and water. Simple Green®, Formula 409® or equivalent works great. Apply cleaner to outside of air filter and allow to soak. Then flush filter clean from the inside out with a garden hose and repeat steps if necessary. Do not apply high pressure water or air to clean filter. Allow filter to air dry and reinstall.